



## Controlled Reactive Power Supplied to Grid by Photo-voltaic Connected

---

Abdallah Abdelslam Elgohary,  
Ahmed Abdul Mardi Abdul Wahid Ibrahim and  
Tamer Helmy Abdel Hamid Hassan

EasyChair preprints are intended for rapid dissemination of research results and are integrated with the rest of EasyChair.

October 21, 2019

# Controlled Reactive Power Supplied to Grid by Photovoltaic Connected

1<sup>st</sup> Abdallah Abdelslam Elgohary

Senior Electrical Engineer

Alexandria Distribution Company, Egypt

2<sup>nd</sup> Ahmed Abdul Mardi Abdul Wahid Ibrahim

Assistant Professor in Department of Electrical Engineering

Alexandria University, Egypt

3<sup>rd</sup> Tamer Helmy Abdel Hamid Hassan

Professor in Department of Electrical Engineering

Alexandria University, Egypt

## ABSTRACT

Photovoltaic systems are expected one of the most growing sources of electricity in the next decades, the amount of installed photovoltaic power has rapidly increased. But using photovoltaic systems connected to grid may have drawback effect on the grid parameters. with using more and more photovoltaic panel energy its necessary to investigate them into the power systems, because small residential loads using photovoltaic at maximum power as the main source of the power and the utility use as a backup source interfaced with inverter and this change the characteristics of power flow shape and effect the parameter of the grid, this paper will focus on increase reactive power problem and discuss the ability of solution by control of reactive power and active power of photovoltaic inverter output to improve the efficiency of the grid.

**Keyword:** Photovoltaic, Connected to Grid, Reactive power, Inverter control

## 1.1. Introduction:

Utilizing renewable sources energy such as solar and wind to generate electricity provides a feasible solution for Global warming due to pollutants increase when fossil fuels are converted into electricity or heat, in this day about 80% of our energy from non-renewable energy sources, therefor atmosphere is damaged. Photovoltaic systems are widely using today, The world is moving to use renewable energies as one of the solutions to save the planet from pollutions, photovoltaic systems installed in the whole world become in 2017 approximate about (403 GW) power. Figure (1) shows the exponential growth of global solar energy in the world. [1]

When the generated power from photovoltaic system is not sufficient to meet the load demand, the energy accessed from grid connected through net meter which guarantee the reliability of the system at the consumer end. The biggest challenge in design in this system is make sure that the utility system will not be harm with photovoltaic system connected, where the harmonic or power quality, increase reactive power, islanding problem, reverse power and other parameters will affect the power quality of the utility system. We will preview increase reactive power problem caused to the grid by photovoltaic system connected, preview the control technics can be used to avoid this problem, presenting electric and control circuit of the system and simulate the system to achieve the desire.

## 2.1. Increasing reactive power problem in grid caused by photovoltaic system:

In photovoltaic connected to grid system output DC voltage from Photovoltaic array converted to the desired AC voltage of the grid and then injected to the grid by power electronic interface device or inverter, inverter internationally designed to operate at unity power factor according to two reasons the first one the IEEE 929-2000 current standard do not allowed the inverter of photovoltaic system to operate in voltage regulation mode, [2] the other reason that the photovoltaic small residential owner they only care about the capacity of active power (P) in (K Watt/hour) they need, not to their reactive power (Q) in

(KVAR/hour), so they prefer to operate the inverter in unity power factor to get the maximum power, As a result the active power (P) in (KW) required to the loads are fed from the photovoltaic system, and reactive power (Q) in (KVAR) of the loads supply completely from the utility networks, so in high penetration level of photovoltaic systems connected to grid that means A high rate of reactive power supply from the grid; and this not preferred by the utilities, because this have many effect on distribution system; such as distribution transformers will operate at very low power factor, so the efficiency of transformers will decrease as their operating power factor decreases, as a result; the overall losses in distribution transformers will increase reducing the overall system efficiency, figure (2) show the power flow across the transformer and the effect of reactive power of photovoltaic system, showing how much the photovoltaic inverter shutting off, switching on effect on the active and reactive power flow across transformer.[3-4]

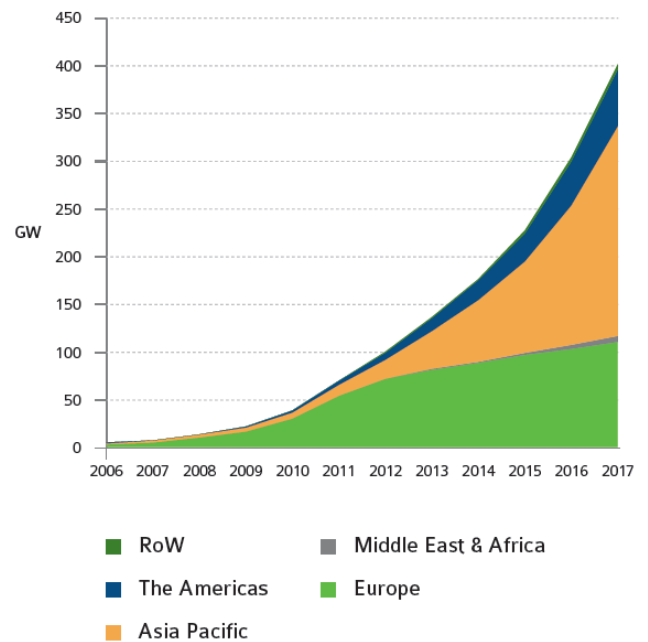

Figure (1) the exponential growth of global solar energy in the world.

However, recently some independent power providers and utilities have shown a big way to use the inverters to provide reactive power (Q) in (KVAR) to the grid, Inverter usually running below its rated output current when converting DC solar power to AC active power. The unused capacity of the PV inverter can then be put to use to produce and inject reactive power to the grid. By utilizing the remaining capacity or slightly increasing the capacity of the inverter, The PV inverter systems can set to provide significant voltage/KVar control to the grid by using closed-loop feedback control system according to the curve in figure (3), and equations (1), (2). Where the inverter either absorbs or injects an amount of reactive power from or to the grid as a function of the measured voltage at its point coming coupling (PCC), and output reactive power (Q) definitely is limited by the apparent power (S) and active power (P) of the photovoltaic-system.[5]If using inverter as voltage supply inverter (VSI) instead of current supply inverter (CSI), reactive power can be supplied and absorbed using the available capacity of the inverter in a specific moment in accordance with the photovoltaic generation time, and demand of the electric power grid. [6]

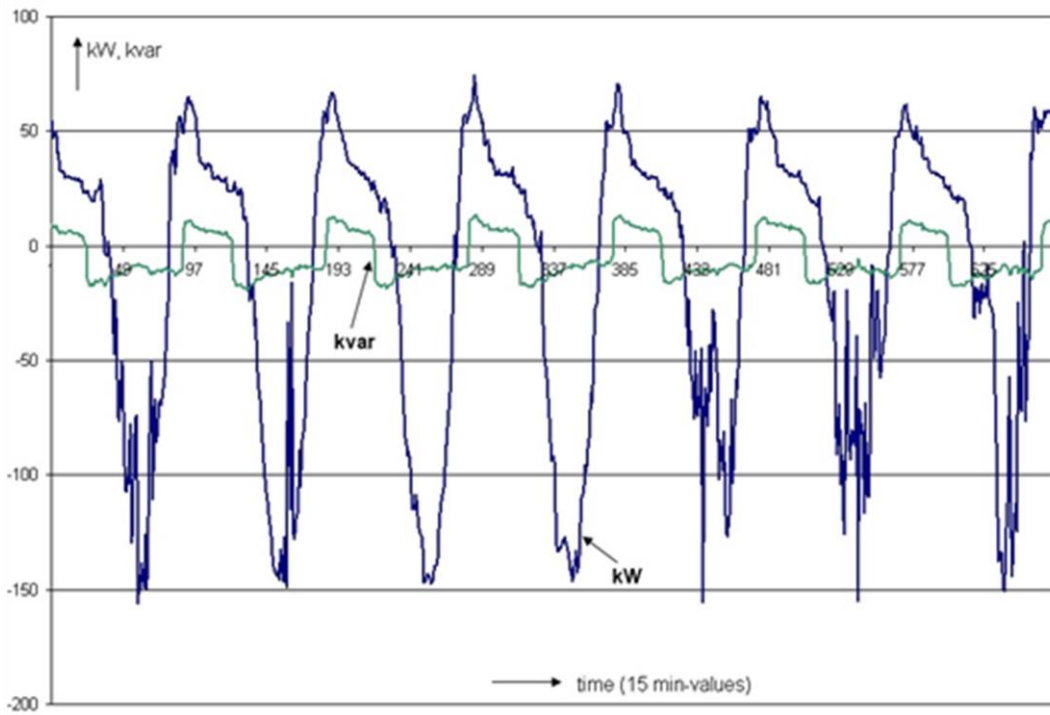

Figure (2) the power flow across the transformer.

$$|Q| \leq \sqrt{S^2 - P^2} \quad (1)$$

$$-S \leq Q_{\min} \leq Q \leq Q_{\max} \leq S \quad (2)$$

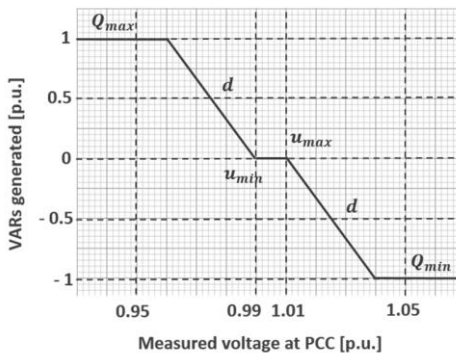

Figure (3) Q (u) curve of Volt/Var control: reactive power absorbed or injected as a function of the measured voltage in PCC.

## 2.2. Principle of operation:

The inverter of photovoltaic can be used similarly to synchronous machine at no load in reactive power compensation, which can supply and absorb active, reactive power according to the following equations (3),(4):

$$P = \frac{V_i V_s}{2\pi f L_c} \sin \delta = P_{\max} \sin \delta \quad (3)$$

$$Q = \frac{V_i^2}{2\pi f L_c} - \frac{V_i V_s}{2\pi f L_c} \cos \delta \quad (4)$$

Where:

$V_i$  → Inverter voltage.

$V_s$  → Supply voltage.

$L_c$  → Inductance of coupling.

$f$  → System frequency.

$\delta$  → Phase difference between [ $V_i$  and  $V_s$ ].

Inverter can be injecting or absorbing reactive power to or from the grid depending on the amplitude voltage of  $V_i$  and  $V_s$ . When  $V_i$  is bigger than  $V_s$  and in phase, mean the inverter provide reactive power to the grid, if the  $V_i$  smaller than  $V_s$  and in phase, mean the inverter absorb reactive power from the grid.

Furthermore, the photovoltaic inverter can absorb or generate active power to or from the grid, when  $V_i$  is advanced or delayed from the  $V_s$  "by an angle  $\delta$  smaller than  $90^\circ$ " with the same voltage magnitude, it has active power generation or absorption respectively. The figure (4) shows the phasor diagram of inverter operation.

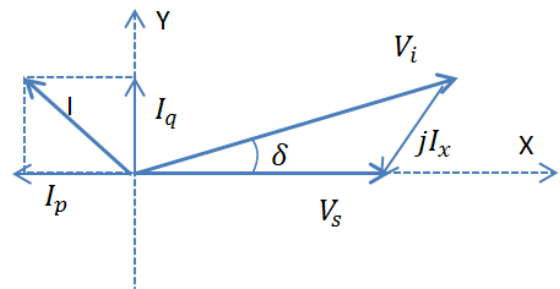

Supplying Active Power Supplying Reactive Power (a)

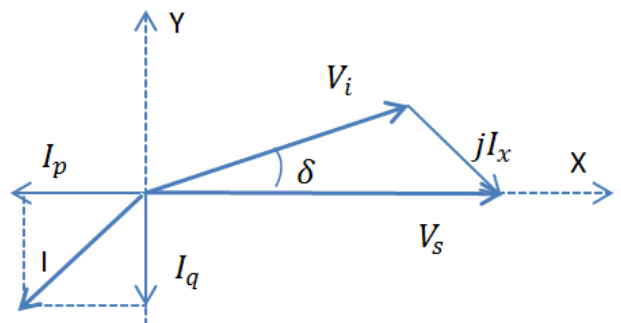

Supplying Active Power Absorbing Reactive Power (b)

Figure (4) Phasor diagram of inverter operation

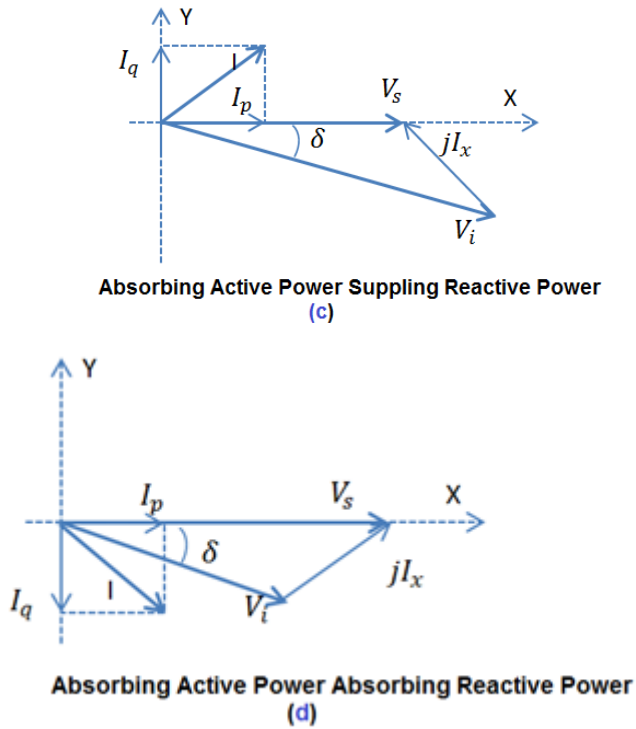

Figure (4) Phasor diagram of inverter operation

### 2.3. Control Limitation:

The inverter power can supplied to the system it must be determined by two option combined together the first one is the power can be provided by the photovoltaic system, the second is the power performance of the inverter itself. Figure (5) shows the operation modes of the inverter.

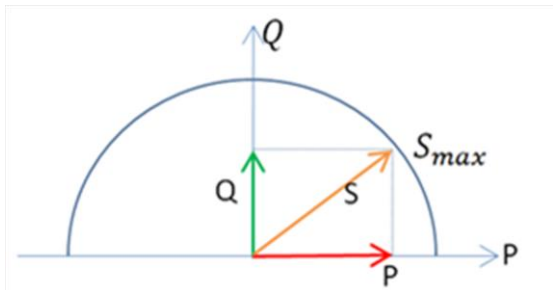

Figure (5) the operation modes of the inverter

The active power supplied from photovoltaic system depending on parameter such as the solar irradiation, the ambient temperature, the movement of clouds, size of the photovoltaic and there location, the active and reactive power can be injected or absorbed to the system is limited to maximum apparent power ( $S_{max}$ ), there are a different strategy commonly use at design such as fixed a maximum point to active power at 70% of rated power, or basing the reduction on a reference signal, as the voltage at the PCC, by using operational curve in figure (6), it can be used in Photovoltaic inverter to set two operation point if the voltage increase at point common coupling (PCC) the specified limits, the inverters adjusts operation of the maximum power point tracking (MPPT) to reduce output power.[7]

Reactive power compensation can be providing by two different types in photovoltaic system inverter, the static reactive power and dynamic reactive power. The static reactive power is use to maintain the voltage level at specific range when supplying drives from operation grid

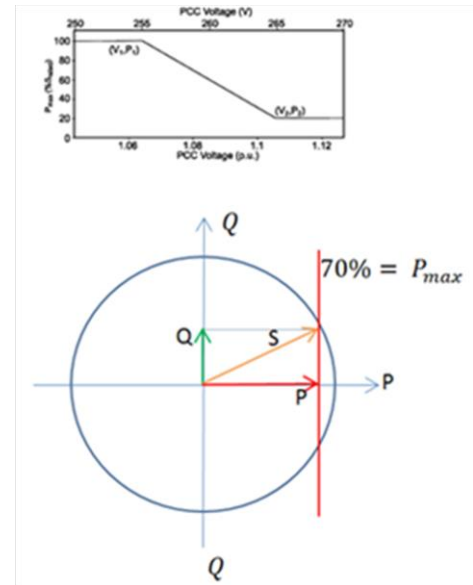

Figure (6) inverter control and operation

system, the dynamic reactive power is use to provide stability to the grid at short term such as voltage sage or peaks occur. [8]

Current PV inverters usually can implement static reactive power compensation by means of four different control strategies: show in figure (7)

(i) Fixed Q, (ii) Fixed  $\cos(\phi)$ , (iii)  $\cos(\phi)$  (P) and (iv) Q (V). [9]

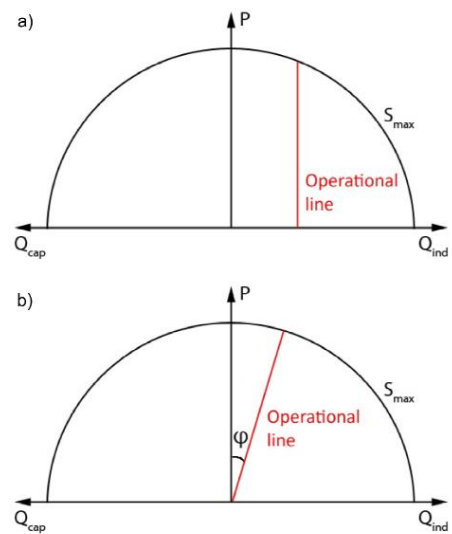

Figure (7) different control strategy (a) Fixed Q, (b) Fixed  $\cos(\phi)$

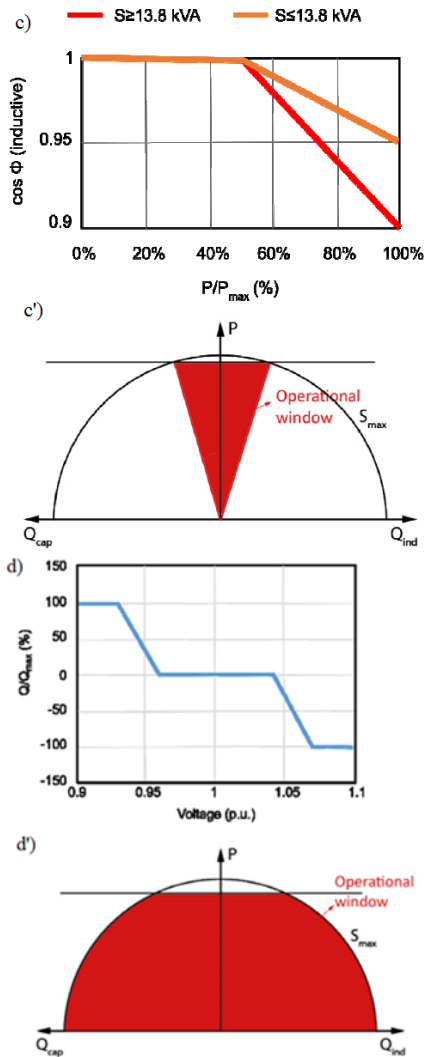

Figure (7) different control strategy (c, c')  $\cos(\phi)$  (P) and (d, d') Q (V).

### 3.1. Electric Power Circuit and Control for Photovoltaic Connected to Grid:

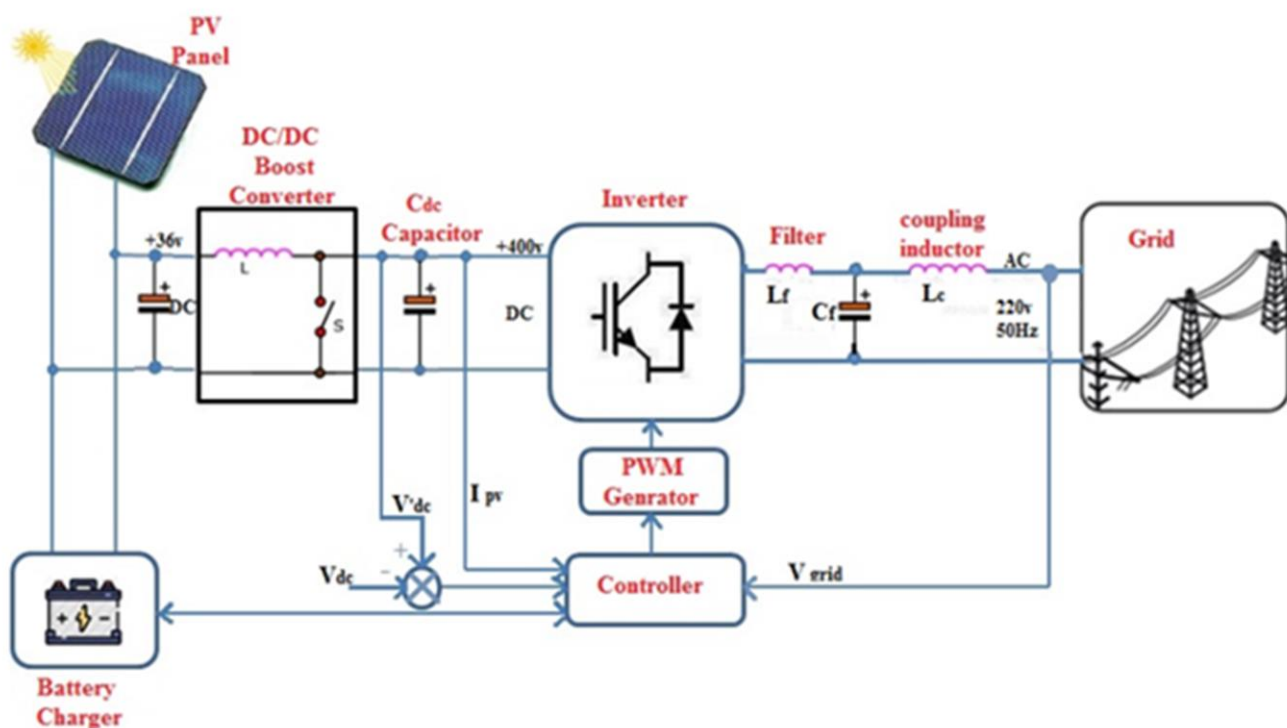

Figure (8) the photovoltaic connected to grid circuit shown

The photovoltaic connected to grid circuit shown in figure (8) using close loop control circuit to control the output power of the photovoltaic array is variable with the temperature of the cells and the insolation level, the boost circuit use to realize the maximum power point tracking (MPPT) of the Photovoltaic array, [10] so the system used according to the need of electric grid of power, absorbing or injected power needed and can be controlled.

### 3.2. Simulations and Result:

Using MATLAB Simulink software to obtain the control of the output active power and reactive power and apparent power supplied to the grid from photovoltaic system by control the inverter output under different value of generation. To development this work, using photovoltaic module output 36 volt DC, 3300 W, with 1000 W/m<sup>2</sup> of insolation level and temperature 25°C, 400 volt DC boost output, grid nominal voltage 220 volt AC and 50 Hz Frequency.

The control sets to control the output of inverter and inject reactive power to the grid if the voltage less than (220 V) and absorb reactive power from the grid if the voltage bigger than 220, using parameter control of the following table (1).

Table (1) parameter control of power circuit

Fs (KHz)	Vdc (V)	Cdc (μF)	Lf (mH)	Cf (μF)	Lc (mH)
18	400	500	0.8	60	5

Figure (9, 10, 11 and 12) shows the result when the grid voltage less than (220V) and need to inject reactive power to the grid, under different generation level.

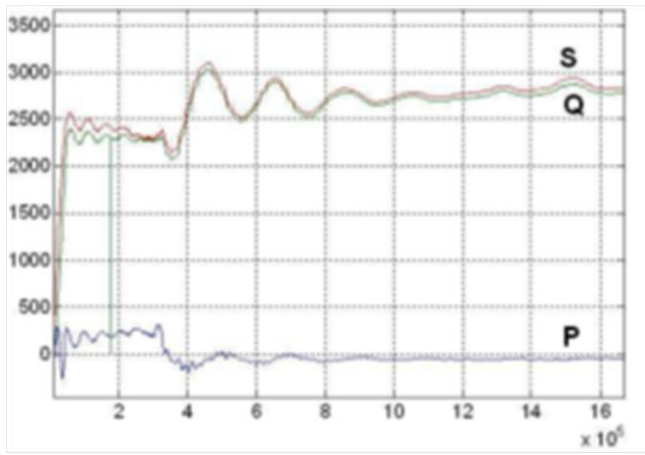

Figure (9) active, reactive and apparent powers supplied by the inverter with 0% of generation in the photovoltaic system

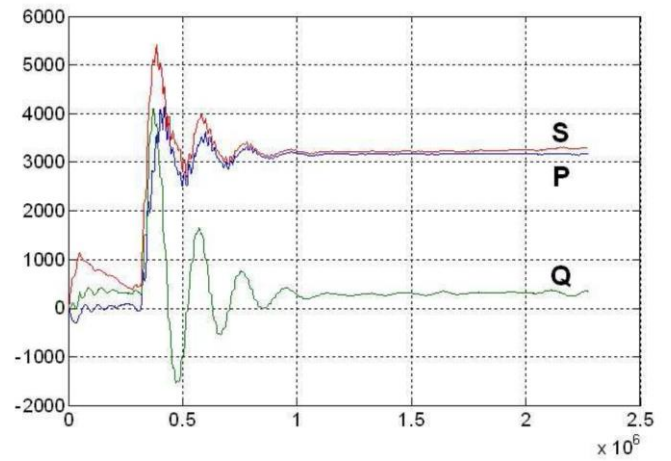

Figure (12) Active, reactive and apparent powers supplied by the inverter with 100% of generation in the photovoltaic system

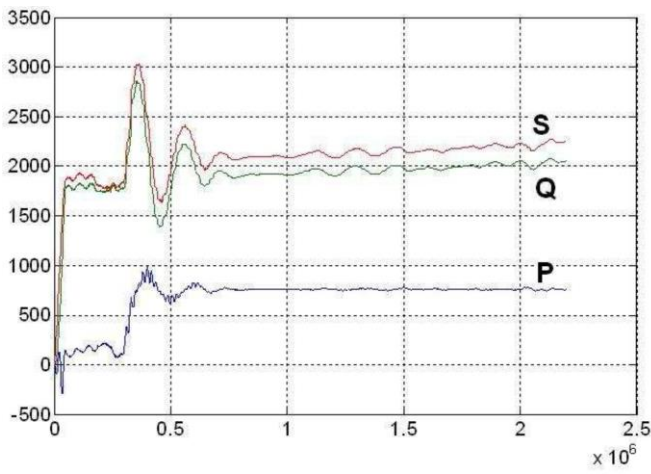

Figure (10) Active, reactive and apparent powers supplied by the inverter with 25% of generation in the photovoltaic system

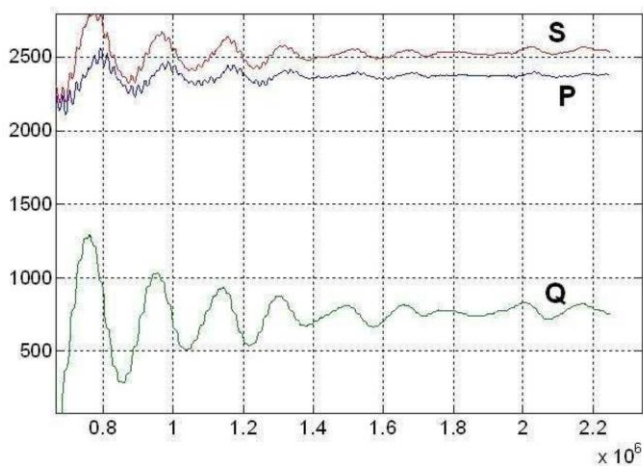

Figure (11) Active, reactive and apparent powers supplied by the inverter with 75% of generation in the photovoltaic system

From the previous figure it is clear how to supply the electrical grid with reactive power from photovoltaic system, when the photovoltaic generation level changes, it is clear that the active power has increase with the level of generation increase, the reactive power decrease according to limitation of maximum apparent power with different generation level, and it is clear that the control system is working very efficiently. The figure (13, 14, 15 and 16) shown the result when the grid voltage bigger than (220 V) and need to absorb reactive power from grid, under different generation level.

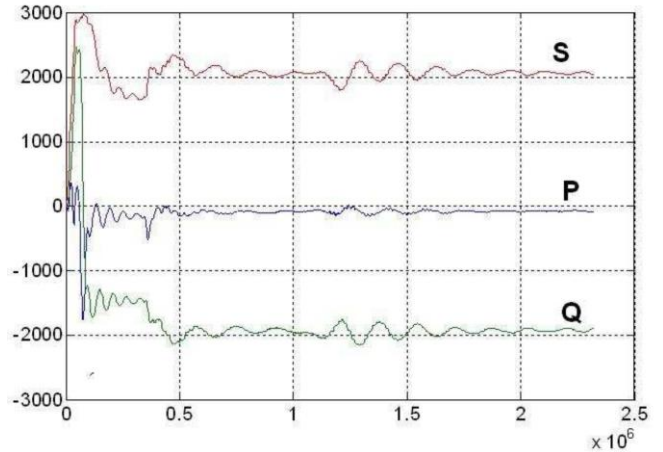

Figure (13) Active, reactive and apparent powers supplied by the inverter with 0% of generation in the photovoltaic system

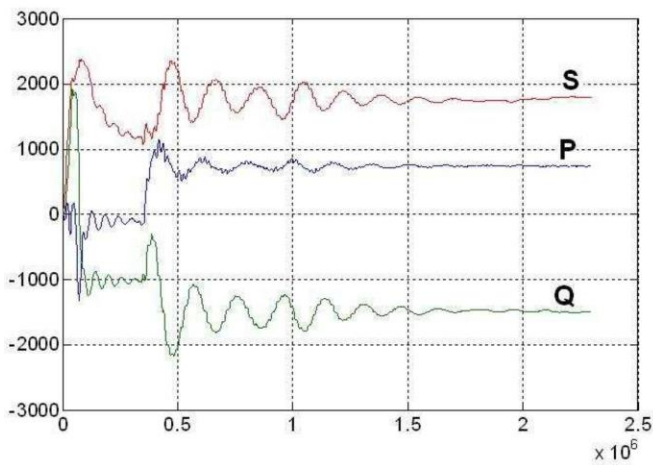

Figure (14) Active, reactive and apparent powers supplied by the inverter with 25% of generation in the photovoltaic system

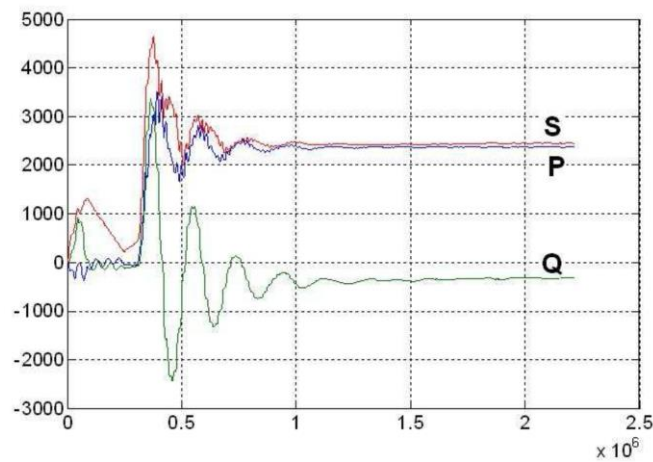

Figure (15) Active, reactive and apparent powers supplied by the inverter with 75% of generation in the photovoltaic system

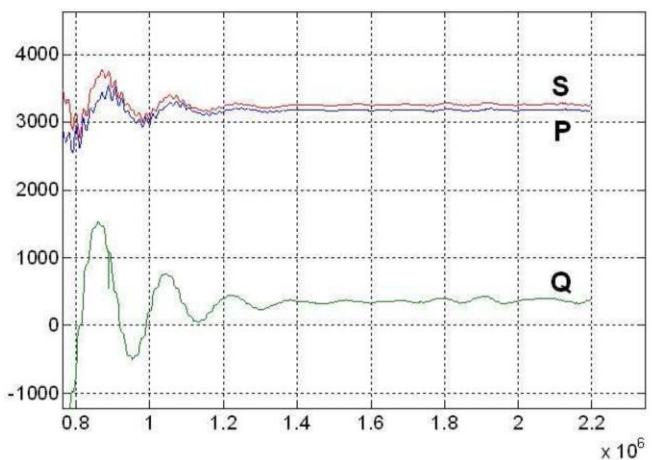

Figure (16) Active, reactive and apparent powers supplied by the inverter with 100% of generation in the photovoltaic system

From the figure above it is clear that it absorbs reactive power from the grid, when the output level is increased, the absorbed reactive power decreases according to limitation of increasing active power, and the control system work efficiently.

#### 4. CONCLUSIONS:

A grid-connected PHOTOVOLTAIC SYSTEM IS A GOOD WAY that can be used to satisfy customers with their electrical feed AND SAVE THE COST OF CONSUMPTION. BUT IT CAN EFFECT TO the network EFFICIENCY, but using the appropriate control system can control THESE EFFECTS and make it USEFUL FOR THE ELECTRICAL GRID.

#### References

- [1] - IEA PVPS TRENDS 2018 IN PHOTOVOLTAIC APPLICATIONS Survey Report of Selected IEA Countries between (1992-2017).
- [2] - IEEE STD 929-2000: 'IEEE recommended practice for utility interface of photovoltaic (PV) systems', 2000
- [3] - A. Burgio, D. Menniti, G. Brusco, A. Pinnarelli and N. Sorrentino," Design of a grid-connected Photovoltaic system with grid ancillary services" 2013 Africon
- [4] - S. Cobben, B. Gaidden, and H. Laukamp, "Impact of photovoltaic generation on power quality in urban areas with high PV population" PV upscale 2008
- [5] - M. William, S. Yves, B. Christophe, H. Andreas, and A. Jean. "Automated quantification of PV hosting capacity in distribution networks under user-defined control and optimization procedures" the European Union's Horizon 2020 research and innovation programmed under grant agreement n°731211, project SABINA. IEEE 2018.
- [6] - M. Begović, A. Pregelj, A. Rohatgi, and D. Novosel, "Impact of Renewable Distributed Generation on Power Systems" Proceedings of the 34th Hawaii International Conference on System Sciences - 2001.
- [7] - K. Turitsyn, P. Sulc, and M. Chertkov, Book "Local Control of Reactive Power by Distributed Photovoltaic Generators"
- [8] - T. Stetz, M. Reking, and I. T. Theologitis, "Transition from Unidirectional to Bi-Directional Distribution Grids" 2014.
- [9] - J. González, D. Ramallo, B. Díaz, J. Pérez, J. Rodríguez, J. Sánchez and R. Lemus "Reactive power management in photovoltaic installations connected to low-voltage grids to avoid active power curtailment"(ICREPQ'18).
- [10] - S. Jiang, D. Cao, Y. Li and F. Peng, "Grid-Connected Boost-Half-Bridge Photovoltaic Micro inverter System Using Repetitive Current Control and Maximum Power Point Tracking" 2012 IEEE